

אותיות הא"ב / הפֿרַת האוֹתִיֹות





כְּתוּבוּ:



א

צַבְעוּ אֶת א.



אַבְטִיחַ



אַרְיֵה

מְצְאוּ 10 א וְצַבְעוּ כְּמוֹ בְדֻגְמָה.

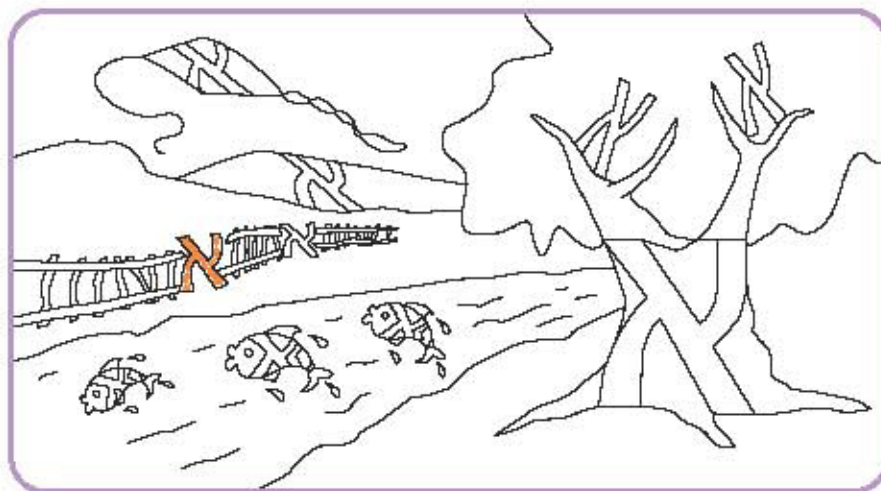

הַקִּיפוּ רַק א כְּמוֹ בְדֻגְמָה.



א נ כ א י ר ו כ ח ע א ט א י ע נ ט א ל
צ מ ו כ ח א צ ת מ צ נ ח א ה מ כ צ י ב



בֵּית

כְּתוּבוּ.



ב

צַבְעוּ אֶת ב.



אַבְטִיחַ



בִּלּוֹן

צַבְעוּ רַק ב כְּמוֹ בְּדִגְמָה.



ר	א	ב	ב	ב	ב	צ
ל	ש	א	נ	א	ב	מ
ס	ח	ש	כ	צ	ב	מ
ג	א	צ	ג	י	ב	א
מ	א	ג	ד	ד	ב	ש
ט	ו	ב	ב	ב	ב	ב

הַקִּיפוּ רַק ב כְּמוֹ בְּדִגְמָה.



ב ס נ ד מ נ כ ב י נ ר ו ת כ נ ב כ ח ע
נ ח מ א י ע ט כ ת נ י ח ו ח ב כ נ ת

כְּתוּבוּ.



ג

צַבְעוּ אֶת ג.



גְּלִידָה

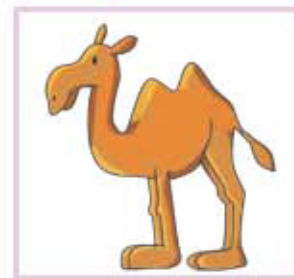

גִּמְלָה

צַבְעוּ רַק ג כְּמוֹ בְדֻגְמָה.

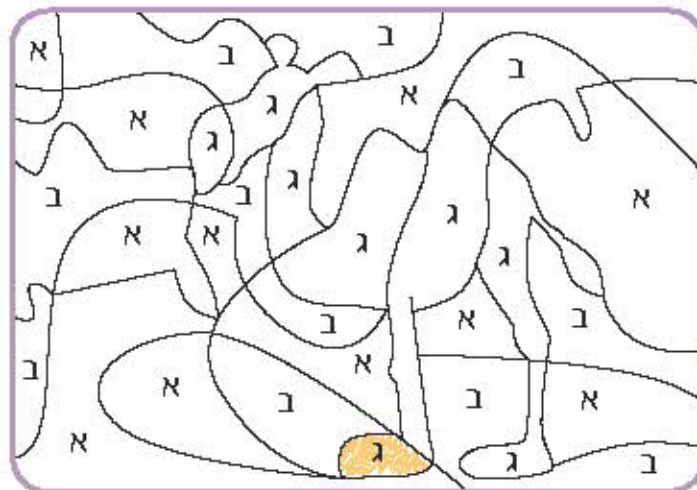

הַקִּיפוּ רַק ג.



ג מ צ כ ג א ט ע י ר ג ג ח ג ע ג נ ב ע
ג צ כ צ מ ע ג מ ג א ג צ ע מ ר ו ג ח ג ג נ

פְּתוּבוּ.



ד

צַבְעוּ אֶת ד.



דָּגָל

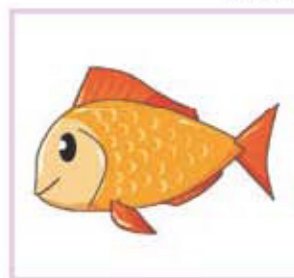

דָּג

מְצְאוּ 10 ד וצַבְעוּ.

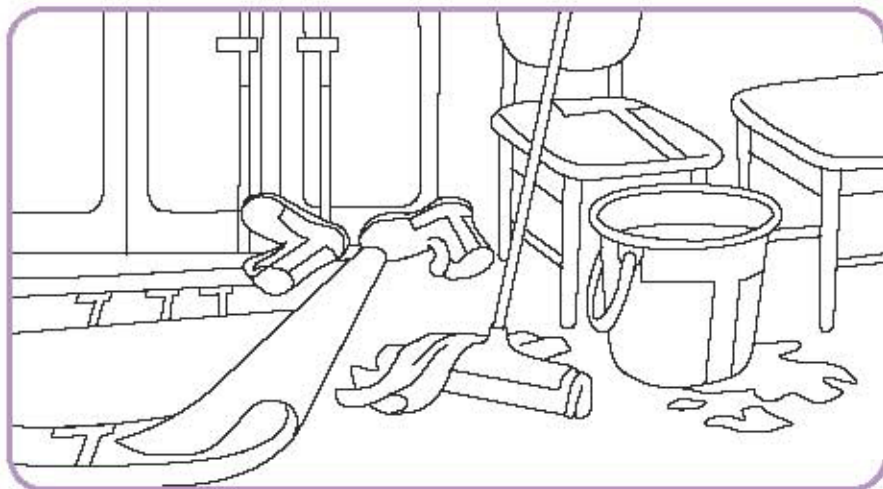

הַקִּיפוּ רַק ד.



ד ר ה ד נ ח ד ה ר ד נ ב ד ו י ו ד ר ד
ה ר י ג ד ר ב ח ה ד ו י ו ד ר י ו ד י ק ר



פְּתוּבוּ.



ה

צַבְעוּ אֶת הַ.



הַר

צַבְעוּ רַק הַ כְּמוֹ בְדֻגְמָה.



ט	ה	ה	ה	ה	ב	א
ק	ר	ו	נ	ה	ק	ר
ח	י	ר	א	ה	ב	א
א	ה	ח	ר	ה	א	ר
ג	ה	ק	ד	ה	ב	ג
ב	ה	מ	כ	ה	ד	ב

חֲקִיפוּ רַק הַ.

 ח ה י ר כ ח ה י ה ב ר ק ה ר ב ו י ה
 י ג ה ר ק ה ח ל י י ח ק ר ה ה ד ר



פְּתוּבוּ.



ו

צַבְעוּ אֶת ו.



וּלְוֹן



וֶרְדִּים

מְצַאוּ 10 וּ וְצַבְעוּ.

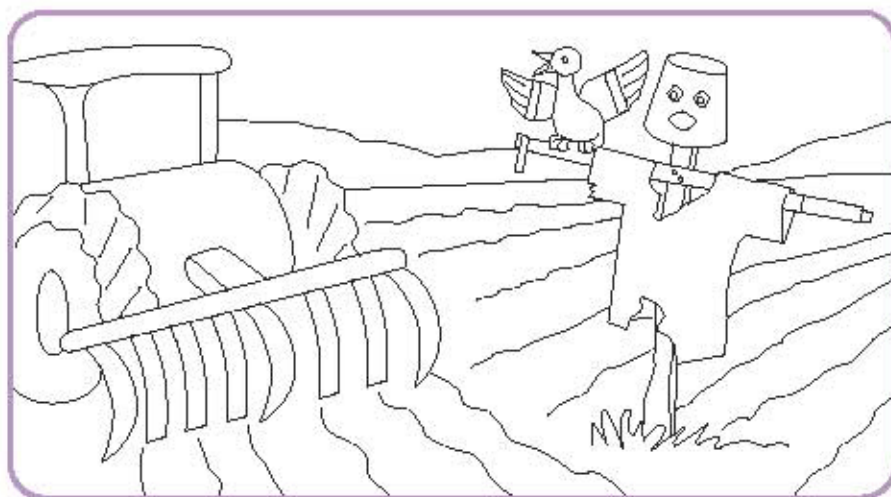

הַקִּיפּוּ נֶקֶוּ ו.



וּרְיוֹק אֶרְיוֹק בּוּיֶגֶק דּוּגֶק
יֶרְדּוּי אֶיֹק רְבֵה הוּיֶק גְּרֵהוּ



כתבו.



ז

צבעו את ז.

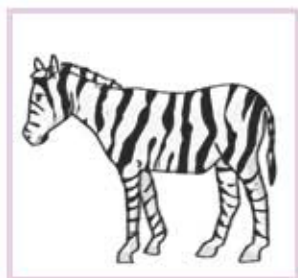

זברה



זית

מצאו 10 ז וצבעו.

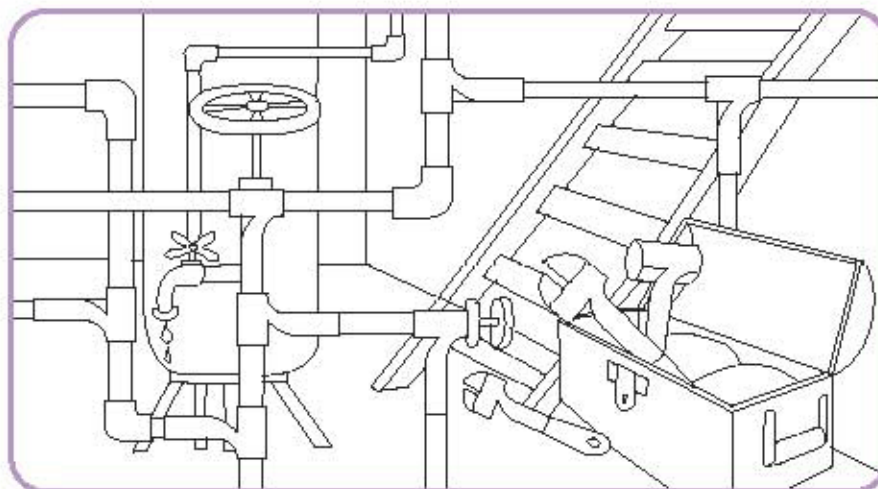

הקיפו רק ז.



ז מ צ כ ז ח ד מ ז ס י ד נ ז ו ר
א ל ט ז ד ק ל צ ו ז ד י ז ו ז ר ק ט

 פְּתֹבוּ.
 



ח

 צַבְעוּ אֶת ח.
 

חַתּוּל

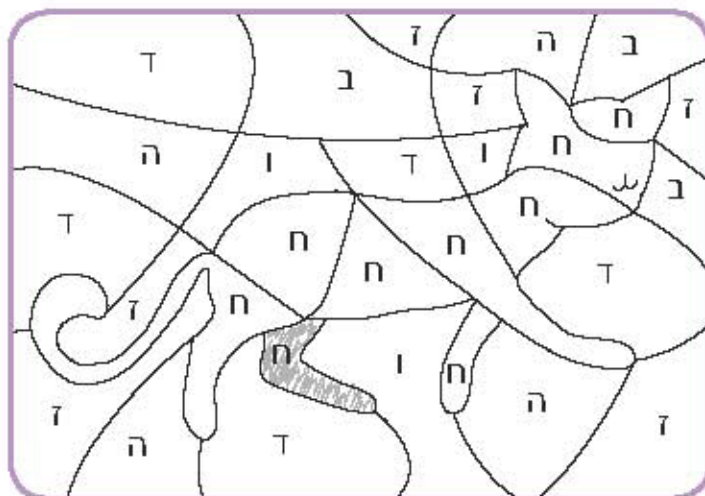

חֹלֵב

 צַבְעוּ רַק ח כְּמוֹ בְדֻגְמָה.
 

 חֲקִיפוּ רַק ח.
 

 ח ת ה ק ח נ ת ח ק ר ח ו כ ח ל ת ח י
 ק ר ח ב כ ר ח ש ת ה ח ר ח ת צ נ ק ר

 כתבו.
 



ט

 צבעו את ט.
 

טֵלפון

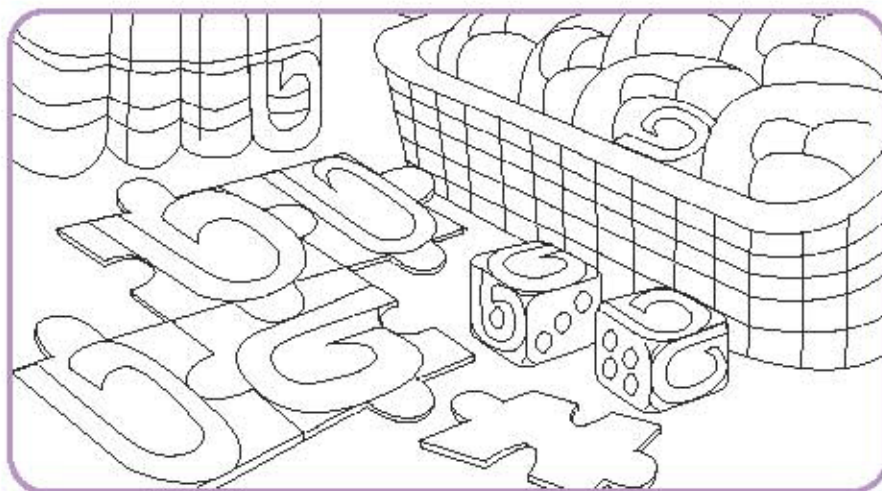

טֶבַח

 מצאו 10 ט וצבעו.
 

 הקיפו רק ט.
 

 ט צ מ ט א ע ו ר י פ ט צ ג מ א
 ע ו ק ט א ר ט י ו ק ב ו י ג פ ק מ ד ט



יוד

פְּתוּבוּ.



ר

צְבִעוּ אֶת יָדְכֶם.



יָד



לְדַה

צְבִעוּ רַק יָדְכֶם.

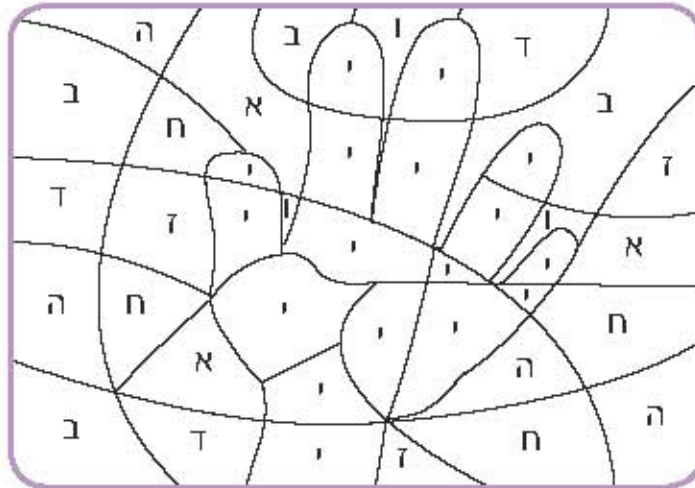

הַקִּיפוּ רַק יָדְכֶם.



ו י ז ו ק ז י א ר י ו ק נ י י ב ו י ג ק
ד ו ג י ק י ר ד ו י א י ו ק ר י ב ה ב ה

כ, ק



כָּר

כָּר כָּר כָּר

כְּתבוּ.



Blank handwriting lines for practicing the letter 'כ'.

צַבְעוּ אֶת פּ וְאֶת כּ וְאֶת רְ.



מֶלֶךְ:



מְכַנְסִים



כֶּלֶב

צַבְעוּ רַק כּ.



ח	ה	כ	כ	כ	כ	ק
ק	ר	ו	נ	ה	כ	ר
ח	י	ר	ק	ה	כ	א
ר	ה	ח	ר	ה	כ	נ
ח	ה	ק	ד	ה	כ	ר
ס	ה	כ	כ	כ	כ	ב

הַקִּיפוּ רַק כּ.



נ ב נ ב פ ח פ נ ב פ ח פ נ ב פ ק ת



ל

פְּתוּבוּ.



ל

צַבְעוּ אֶת ל.



לֶחֶם



לֵימּוֹן

צַבְעוּ רַק ל.

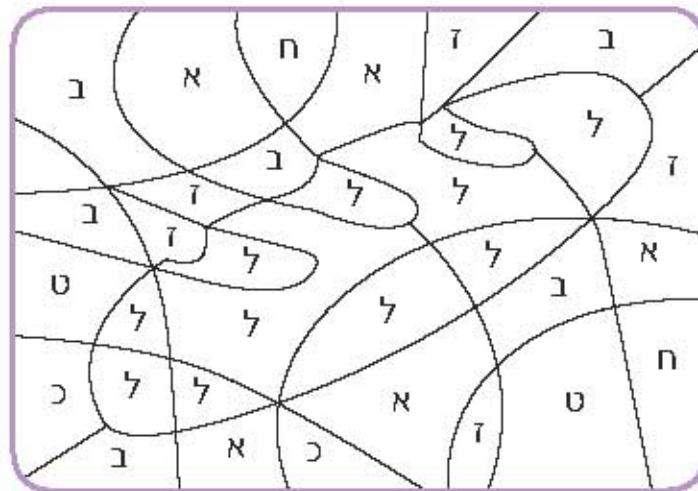

הַקִּיפוּ רַק ל.



ל מ צ א ל מ צ ע א צ ל ג ע א
ל צ ל מ א ע ל צ ר מ ח ו ט ת צ ל



כְּתבוּ.



_____ מ
_____ ם

צַבְעוּ אֶת מ וְאֶת ם.

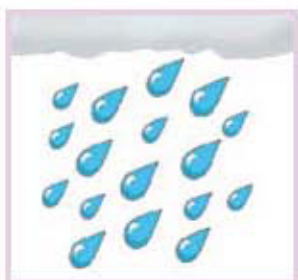

גֶשֶׁם ם



מְחַשֵּׁב

מְצַאוּ 10 מ וְצַבְעוּ.

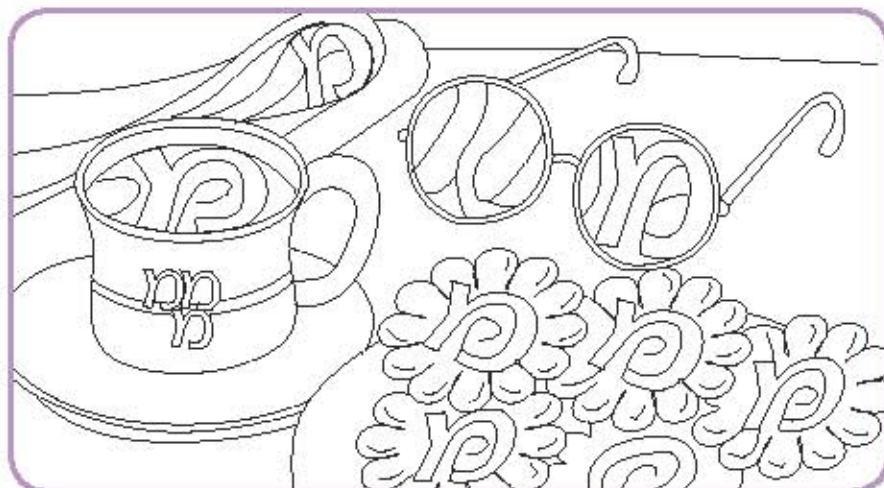

הִקִּיפוּ רֵק ם.



ס ט צ א ע ם ר י פ ט ם צ ג ם א ע ו
ק ט ם א ר ט י ם ק ב ו י ג א פ ק צ ם ד ט

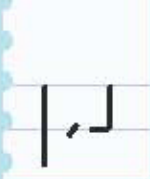

נון



פְּתוּבוּ



Handwriting practice lines with the letter 'נ' on the right side.

צְבִעוּ אֶת נ וְאֶת ו.



שֻׁלְחָן



נֶעַל

צְבִעוּ רַק נ.



ח	ה	כ	כ	נ	נ	ק
ק	ר	ו	א	ה	נ	ר
ח	י	ר	ק	ה	נ	א
ר	ה	ח	ר	ה	נ	כ
ח	ה	ק	ד	ה	נ	ר
ס	ה	כ	נ	נ	נ	ב

הַקִּיפוּ רַק נ.



ו ב ו ב כ ח ת ו ב כ ח ו ב כ ק ת

כְּתוּבוּ.



ס

צְבִעוּ אֶת ס.



סֵפֶר



סַנְדַּל

צְבִעוּ רַק ס.

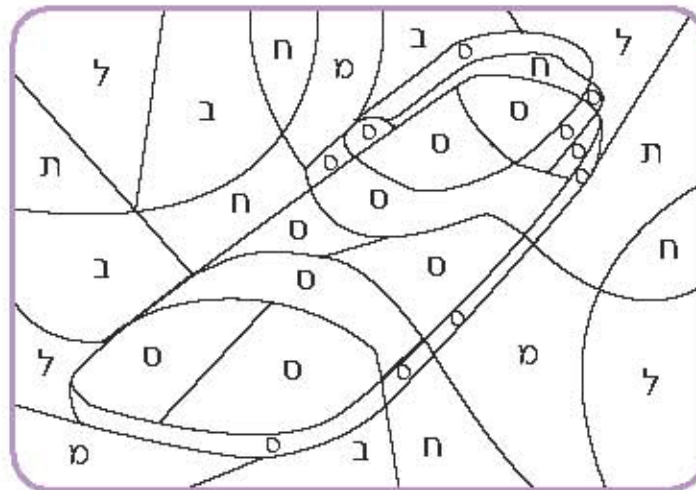

הַקִּיפוּ רַק ס.



ס ל מ ח ל מ ס ד ח ס ח ע א ל צ
ל ט מ א ס ע ס ל צ ר ט ק מ ס ח ו ט ת צ ס ל

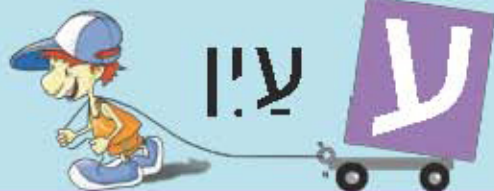

כתבו.



_____ ע

צבעו את ע.



עוגה



עגבניה

מצאו 10 ע וצבעו.

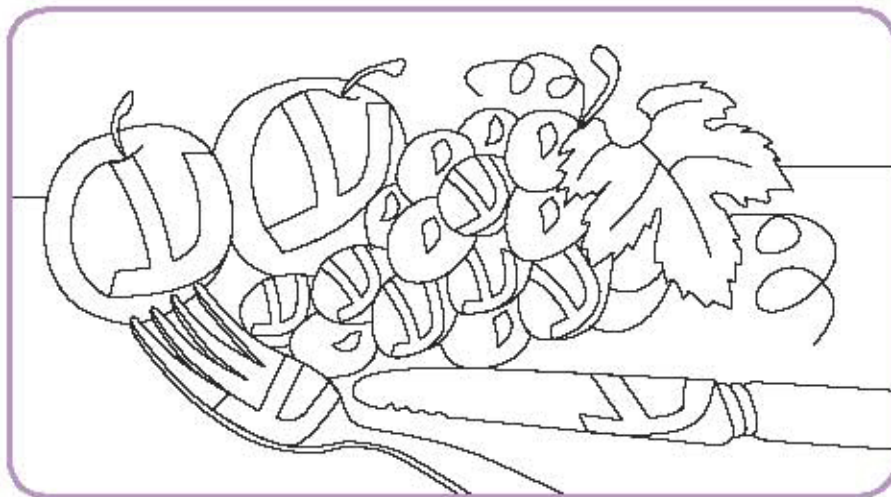

הקיפו רק ע.



ע מ ע מ צ ט א ע מ ו ע ר י פ ט ע
ע ק ט מ א ר ט ע י מ ע ק ב ו ע



כְּתוּבוּ.



פּ

פּ

צְבַעוּ אֶת פּ וְאֶת פּ וְאֶת פּ.



קוֹפֵּץ



טֵלֵפּוֹן

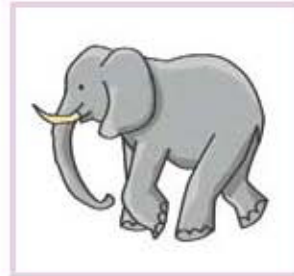

פִּיל

צְבַעוּ רַק פּ.



ח	ה	פ	פ	פ	פ	ב
ע	ר	פ	נ	ה	פ	ר
ח	י	פ	פ	א	פ	ע
ר	ה	ח	ר	נ	פ	נ
ח	ס	ק	ד	מ	פ	ר
ס	ה	פ	פ	פ	פ	ג

הַקִּיפוּ רַק פּ.



פּ בּ בּ נּ מּ תּ חּ טּ פּ כּ טּ בּ נּ בּ פּ
פּ מּ טּ פּ חּ פּ צּ טּ פּ חּ תּ קּ פּ כּ פּ



צְדִי



פְּתוּבוּ.



_____ צ _____

_____ ז _____

צְבִעוּ אֶת צ וְאֶת ז.



עֵץ



צֶבַע

מְצִאוּ 10 צ וְאֶת ז.

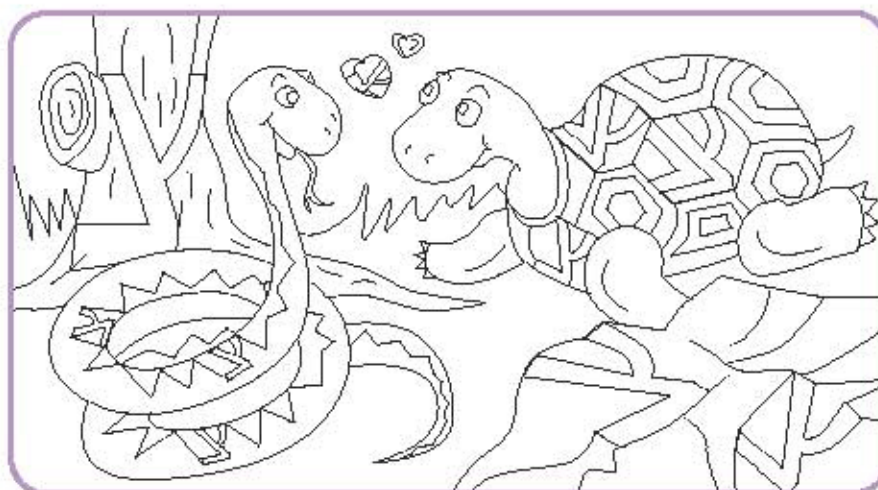

הִקִּיפוּ רַק ז.



ע ז מ ע מ ז ט א ע ז מ ו ע ר ז ז
מ א ז ע ו ע ק ז ט מ א ר ז ט ע ז

כְּתֹבוּ. 

_____ ק _____

צְבֹעוּ אֶת ק. 



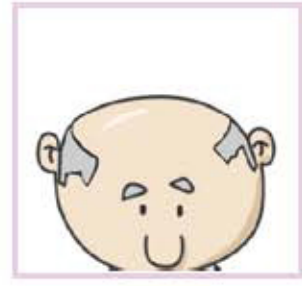

קוף

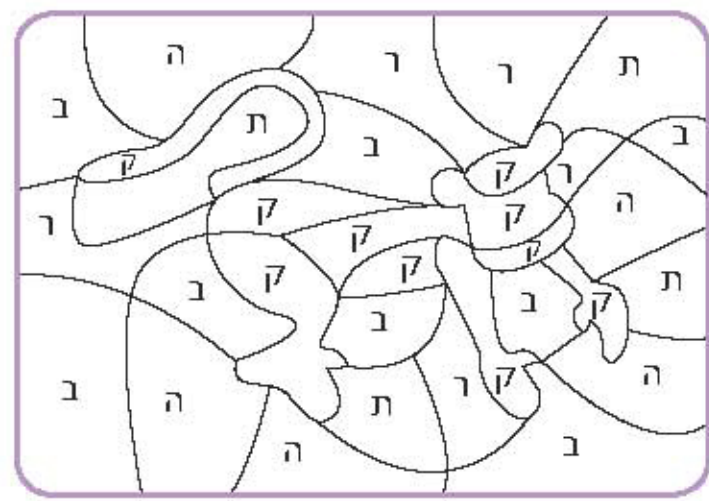

קַרְחַת

צְבֹעוּ רַק ק. 



הַקִּיפוּ רַק ק. 

ח ה ק י ר כ ק ח ה י ק ה ק ב ר ק
ה ק י ג ה ק ר ק ח ק ל י י ק



ר

כְּתֹבוּ.



ר

צְבֹעוּ אֶת הַרְּ.



רְכֵבֵת



רְמִזּוֹר

מְצְאוּ 10 רְּ וְצְבֹעוּ.

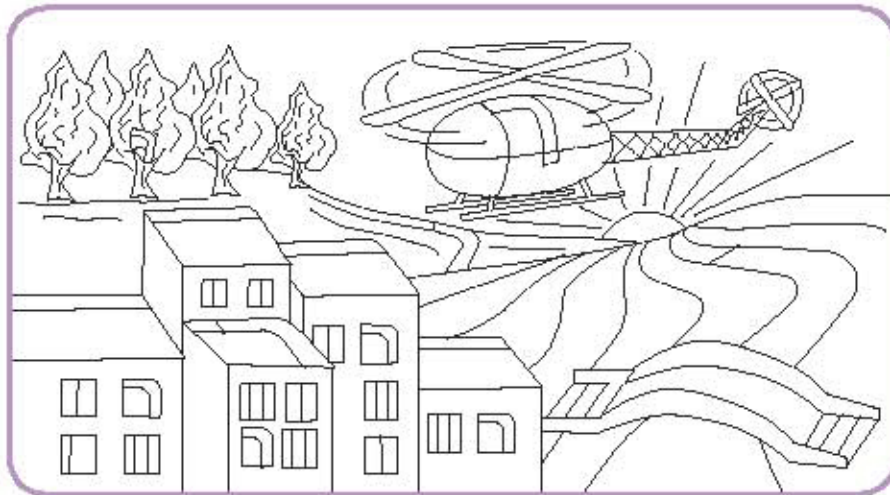

הַקִּיפוּ רְּ.



ח ר ה ק י ר ח ר ה י ק ר ר
ק ר ר ב ו י ה ק י ג ה ק ר ק ה ר

e



כְּתֹבוּ.



ש

צְבֹעוּ אֶת ש.



שֵׁי מְלָה



שֵׁי מֶשׁ

צְבֹעוּ רַק ש.



ח	ש	כ	ש	כ	ש	ק
ק	ש	ו	ש	ה	ש	ר
ח	ש	ר	ש	ה	ש	א
ר	ש	ח	ש	ה	ש	נ
ח	ש	ק	ש	ה	ש	ר
ס	ש	ש	ש	ש	ש	ב

הִקִּיפוּ רַק ש.



ע מ ע ש מ צ ט א ש ע מ ו ע ש ר ש
ג ע ש מ א ע ו ש ע ק ט ש מ א ר ש



פְּתבוּ.



ת

צְבִעוּ אֶת ת.



תְּאוֹת



תְּפֹוחַ

צְבִעוּ רַק ת.

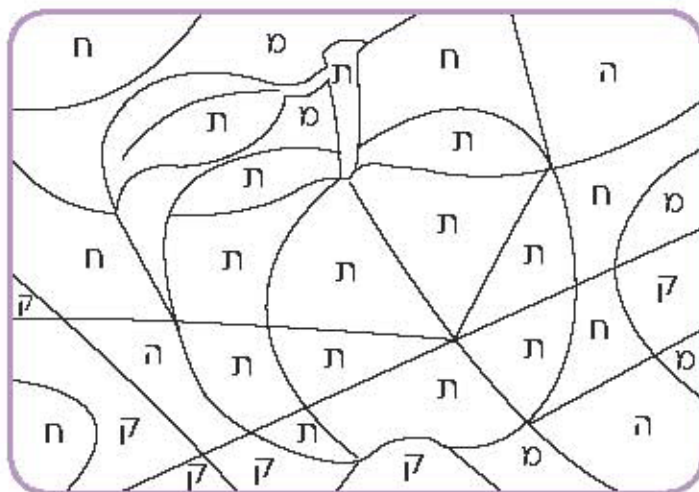

הִקִּיפוּ רַק ת.



ח ת ה ק ת ח נ ת ח ר ק ח ו כ ת ת
ת ק ר ת ח ב כ ר ח ת ש ת ה ח ת ת



ה	ד	ג	ב	ב	א
ט	ח	ז	ו		
מ	ל	כ	כ	ו	
פ	פ	ע	ס	נ	
ת	ש	ש	ר	ק	צ

A girl in a blue suit is pulling a string that starts from a blue cross-shaped handle on the letter 'ל' in the third row, second column, and extends to the letter 'ו' in the second row, fourth column.